

WATER

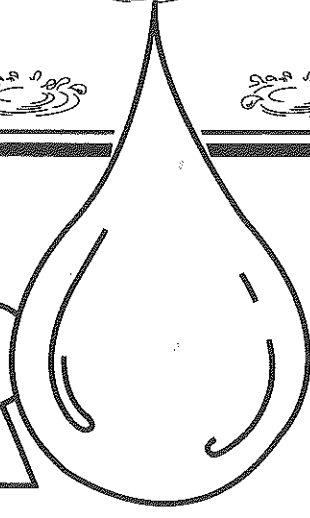

IT RUNS

FOR YOU



Here is some water.
Draw people having fun.
Color the picture.

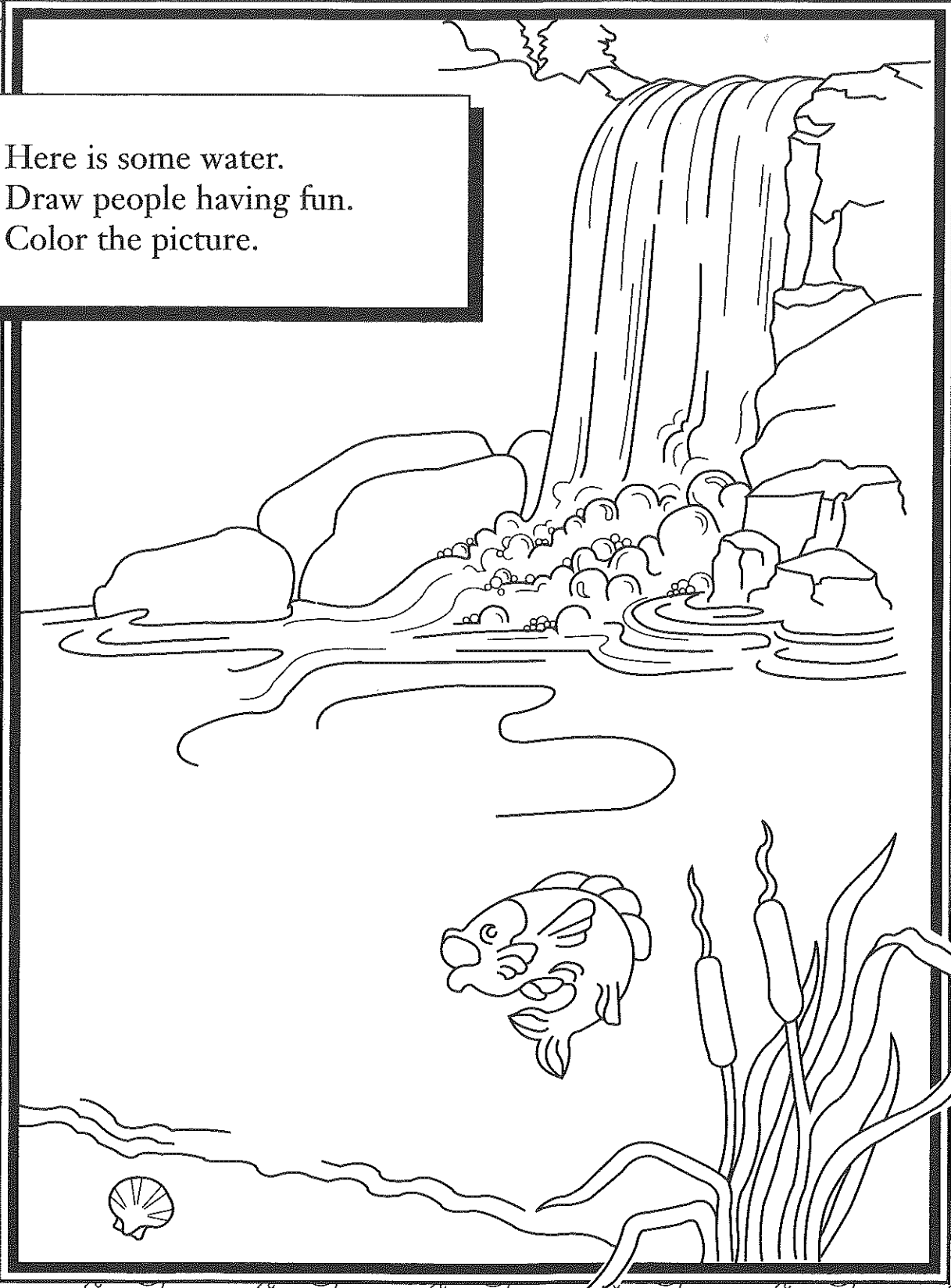

cie

ratew

evirr

keal

ceaon

anir

wnos

krind

gof

laih

Water Words

Put the letters in the right order
to spell some water words.

Count the raindrops in the box.
Draw a circle around the number that
tells how many drops are falling on the
flowers. Color the flowers.



- | | | | | |
|---|---|---|---|----|
| 1 | 2 | 3 | 4 | 5 |
| 6 | 7 | 8 | 9 | 10 |

Design a tee shirt about water.

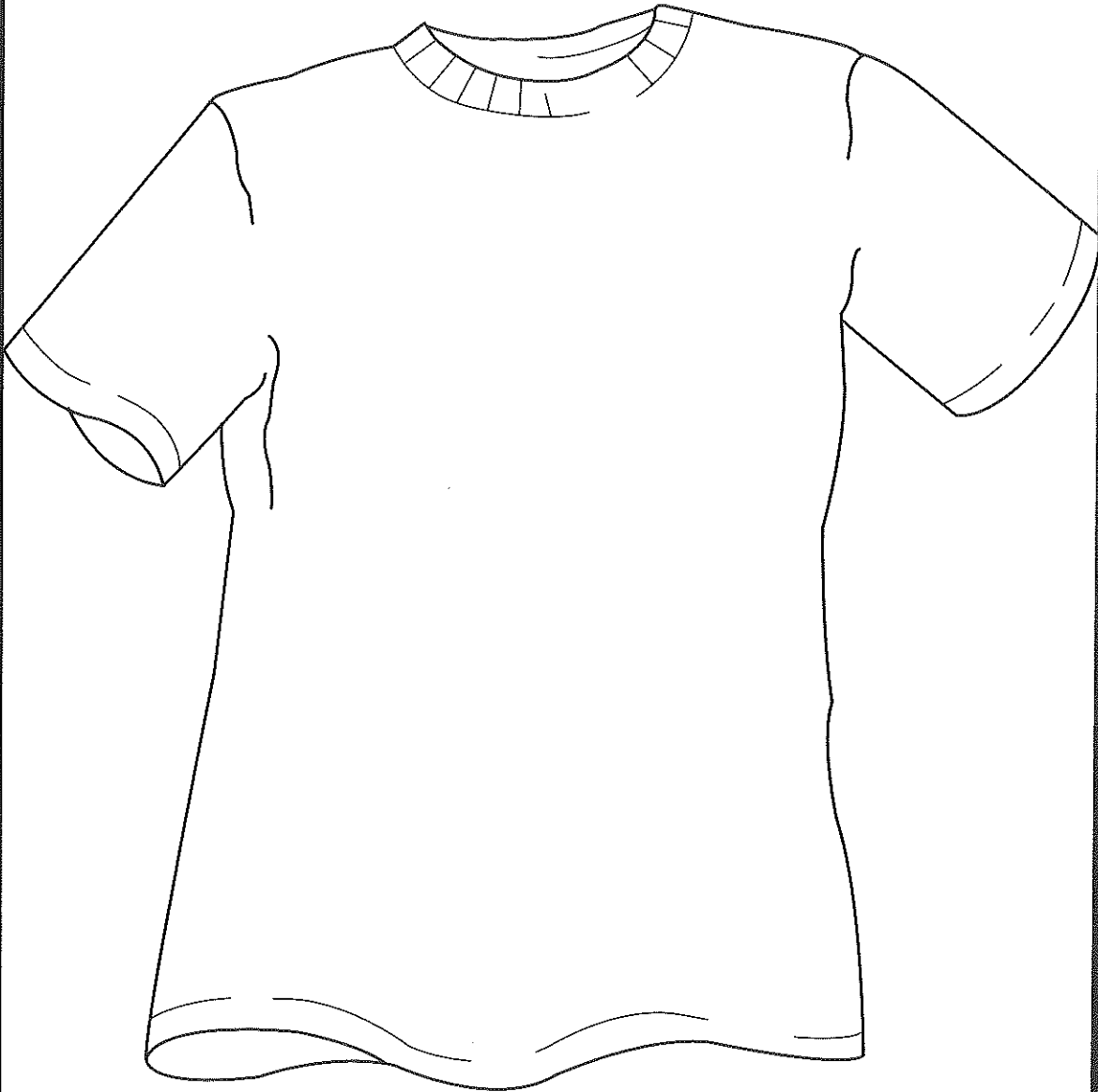

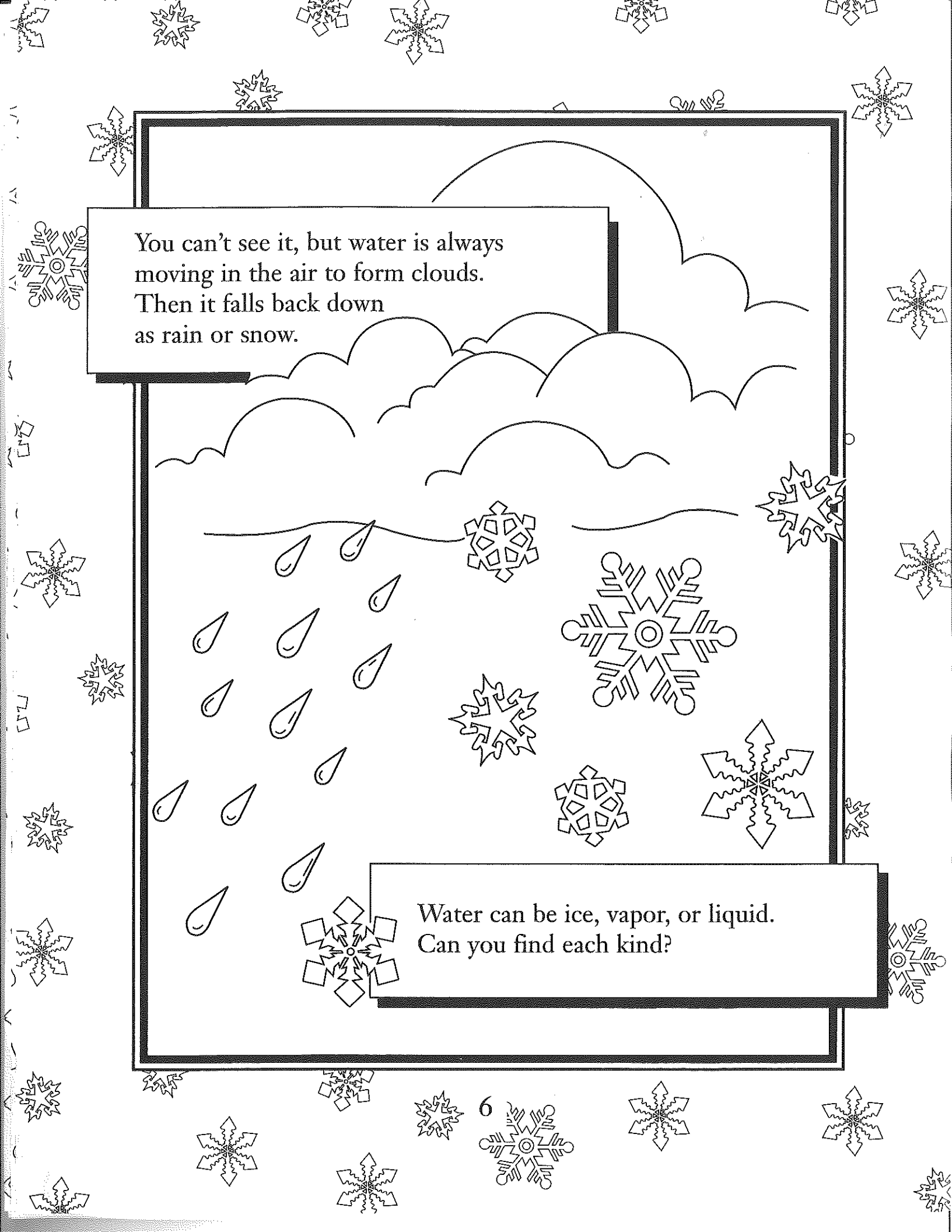

You can't see it, but water is always moving in the air to form clouds. Then it falls back down as rain or snow.

Water can be ice, vapor, or liquid.
Can you find each kind?

The mountains have lots of snow that melts into water. Circle the three trees that are alike. Color the picture.

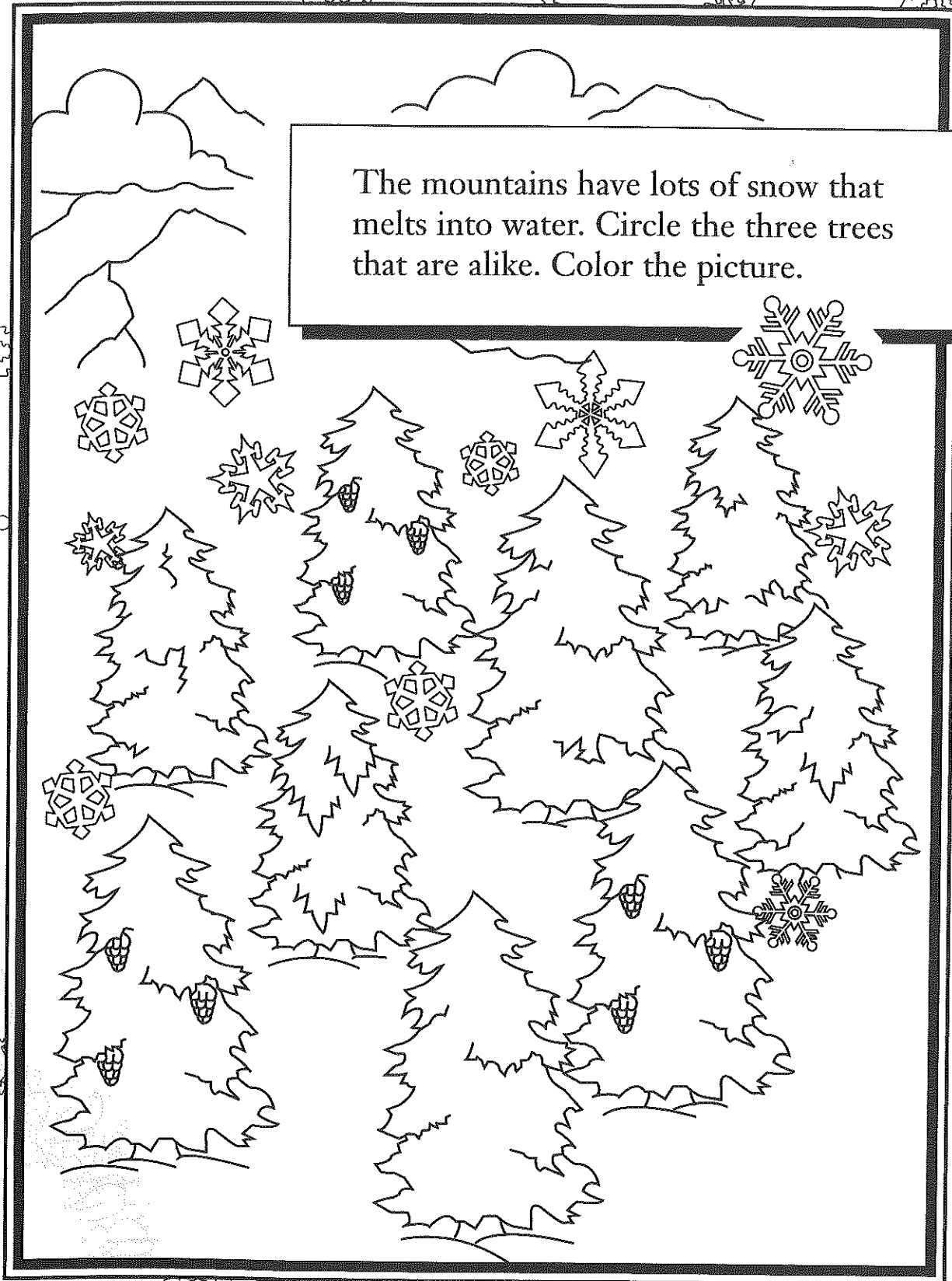

The oceans have salt water.
People cannot drink salt water.
Outline and color the animals
and fish that live in the ocean.

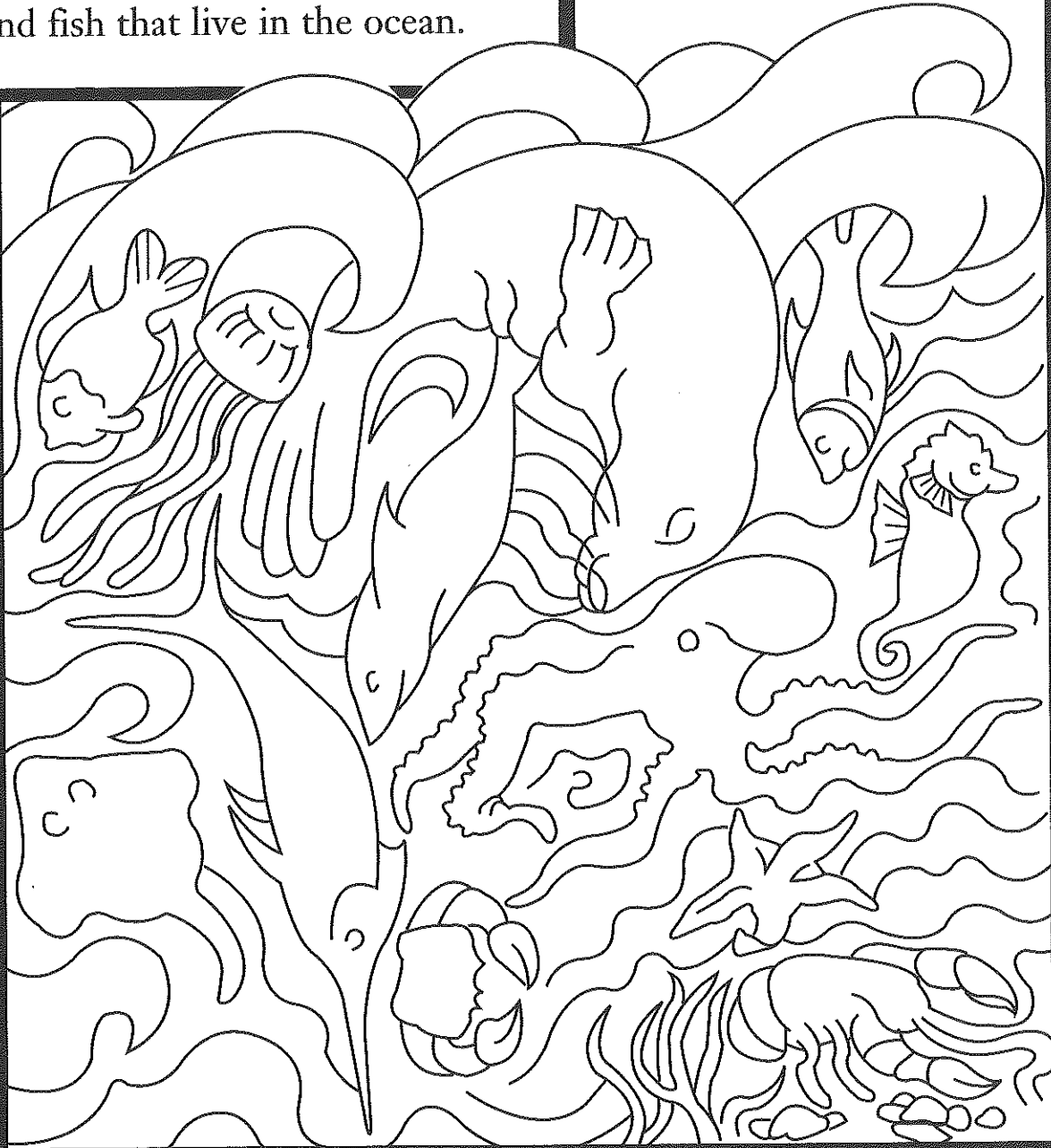

The desert is hot and dry.
The plants and animals that live there need very little water.

ACROSS

- 1. Loose, light soil.
- 4. Very warm.
- 5. This gives us light and heat.
- 7. Stones.

DOWN

- 2. A desert plant that has needles.
- 3. Without water.
- 6. A desert plant that has long leaves.
- 8. Desert reptiles.

		2						8
	1			3	6	Y		
				7	U			
4					C			
					C			
		5			A			

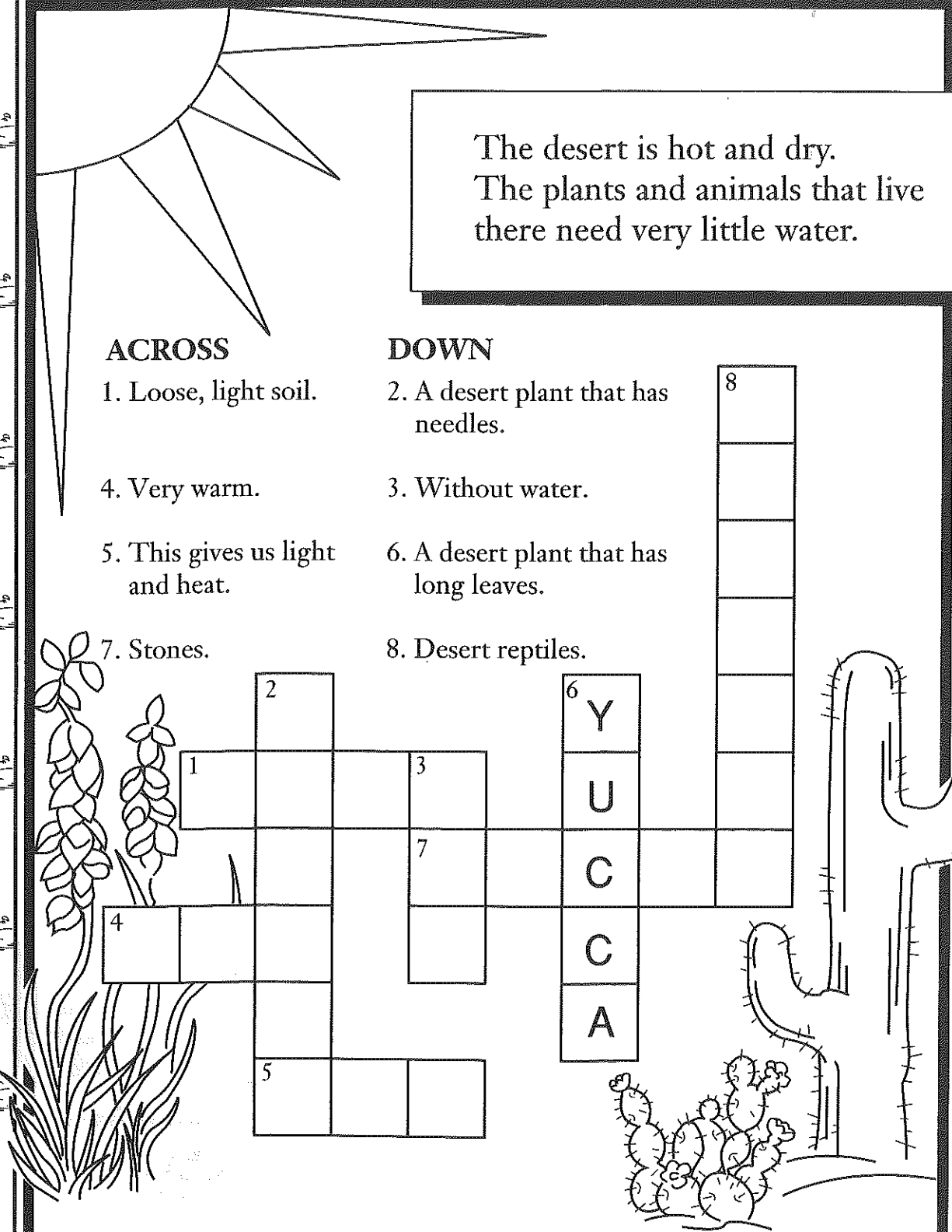

People use lots of water. Use the code to find where the water we use comes from.

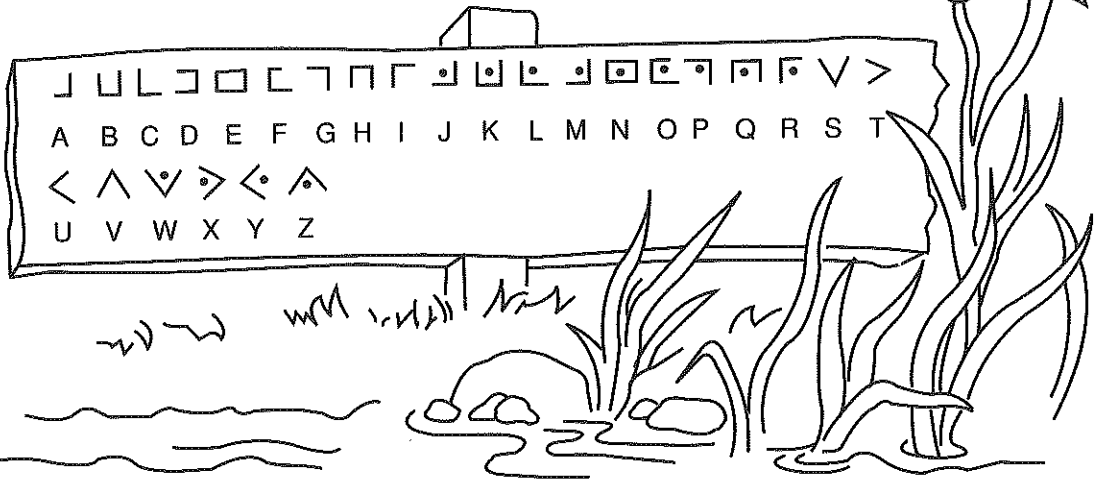

V O < V O V J > O F C F E J E J U O V J O O
 F F A O F V > N G V F V L J E O O V < F C J L O
 V J > O F.

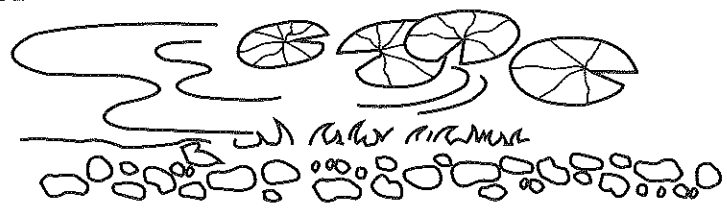

V E J O V J > O F L E J O V C F E J V O E L V
 < O O F > H O F O F < O O . > N G V F V
 L J E O O F O F < O O V J > O F.

Water gets dirty, so before we can drink it, we must clean it. Water is cleaned in a treatment plant and sent to everybody ready to use.

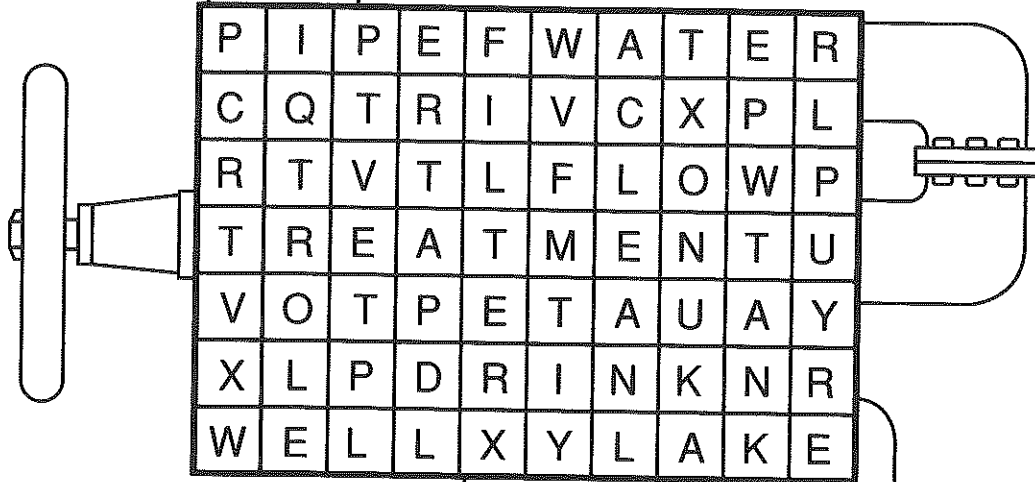
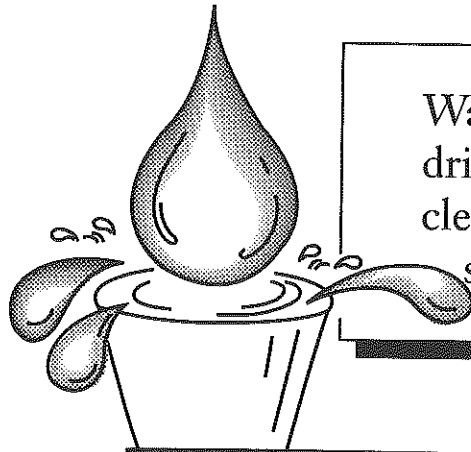

FIND AND CIRCLE THESE WATER WORDS

- | | | |
|-----------|------|-------|
| treatment | tank | clean |
| flow | pipe | water |
| filter | well | |
| drink | lake | |



Water moves from place to place under the ground. Find the right pipes to take the water from the tower to the fountain.

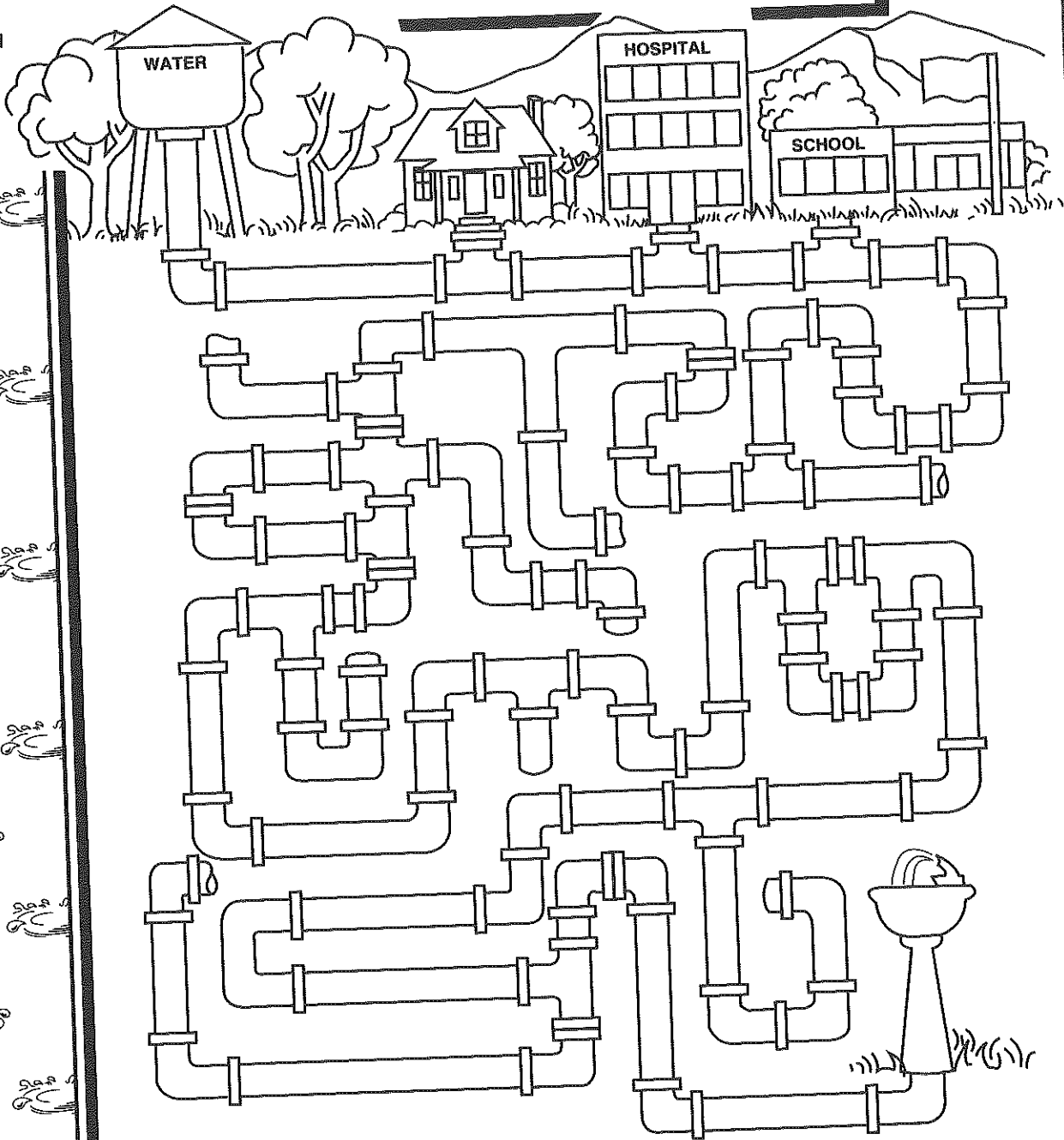

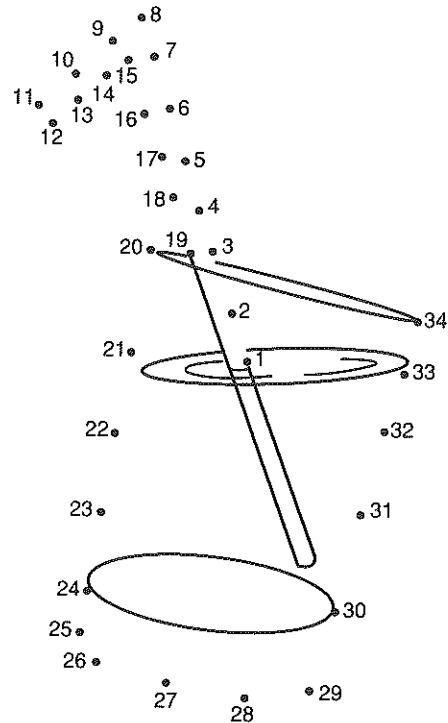

Use a pencil to connect the dots.
Draw yourself taking a drink of water.

We all need water.
So, use water wisely!



PAGE 3

- water • lake
- snow • ice
- river • drink
- hail • rain
- ocean • fog

PAGE 4

Eight raindrops are falling on the flowers.

ANSWER

PAGE 6

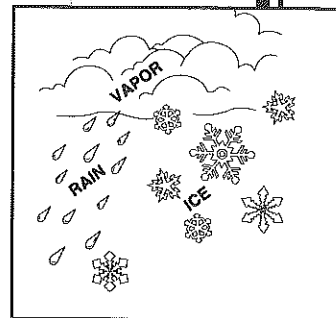

PAGE 8

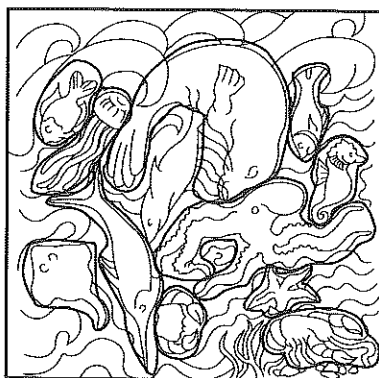

PAGE 7

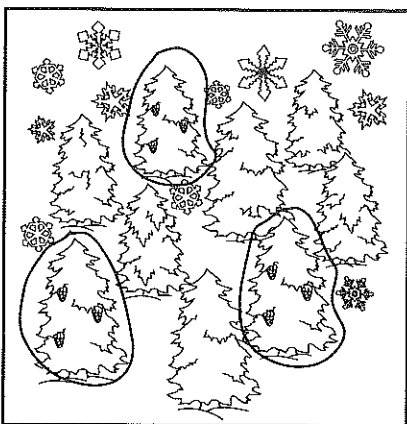

PAGE 9

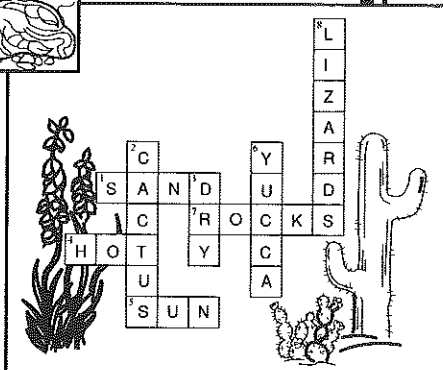

PAGE 10

We use water from lakes and rivers. This is called surface water.

Some water comes from wells under the ground. This is called groundwater.

PAGE 12

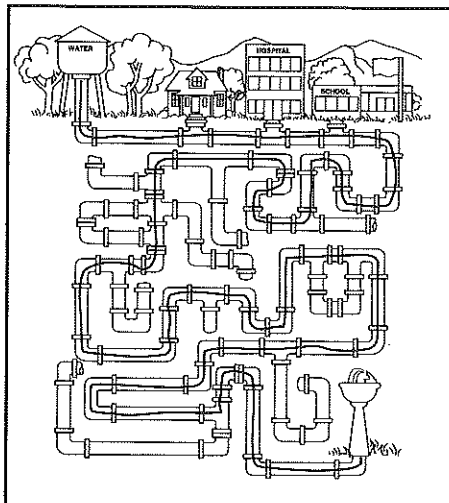

PAGE 11

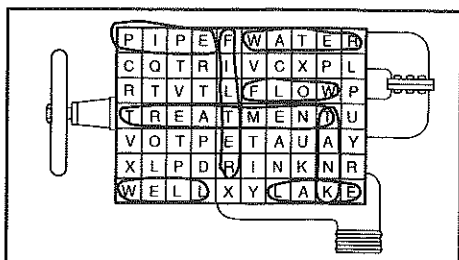



**American Water Works
Association**

The Authoritative Resource for Safe Drinking WaterSM

Printed on recycled paper.

ISBN 0-89867-901-X



9 780898 1679014

18P--15M 70038 (11/13) PP